

Roca

W+W 8-01702

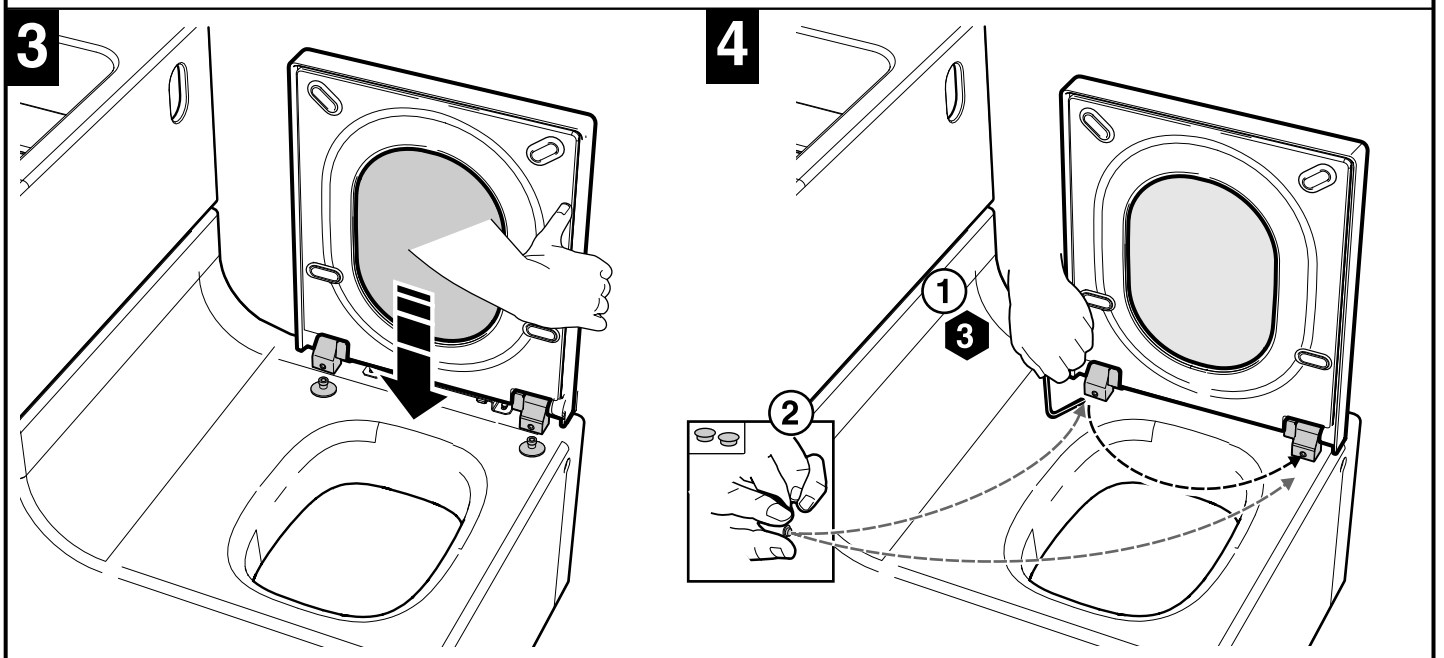

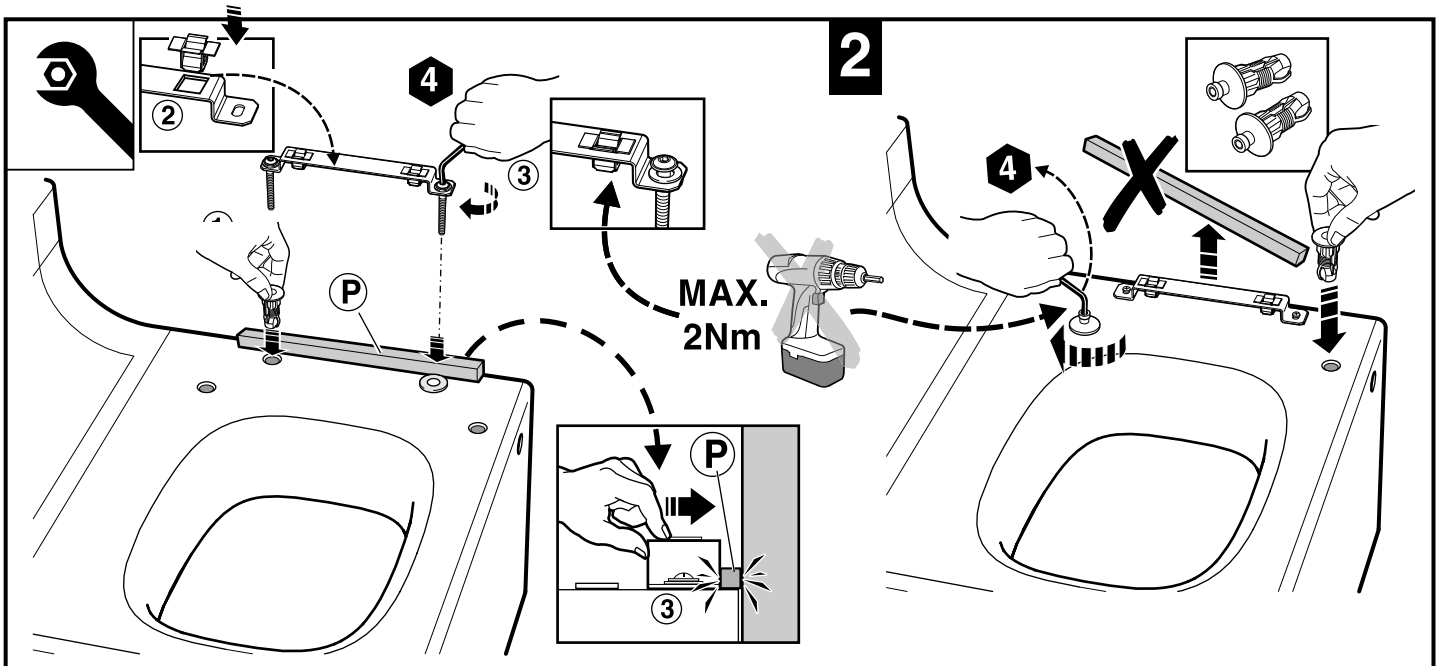
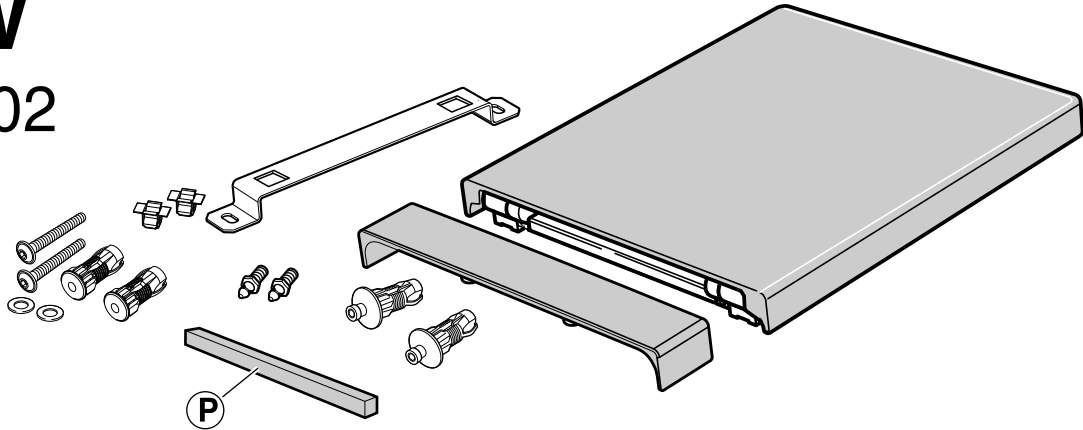
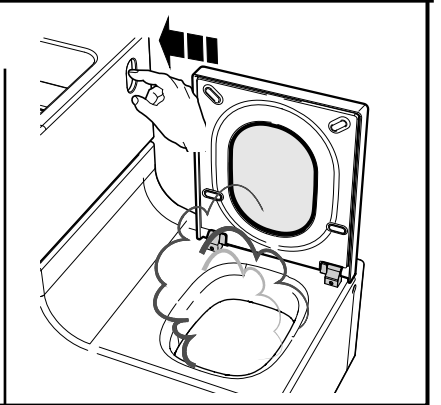
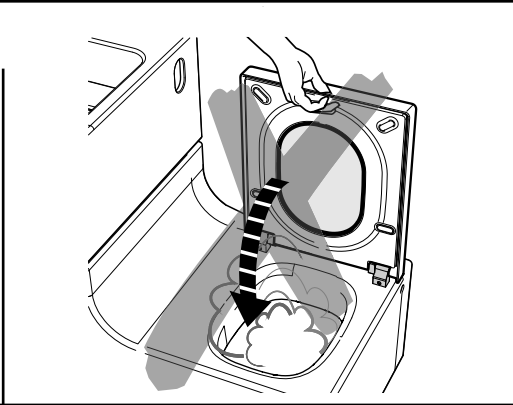
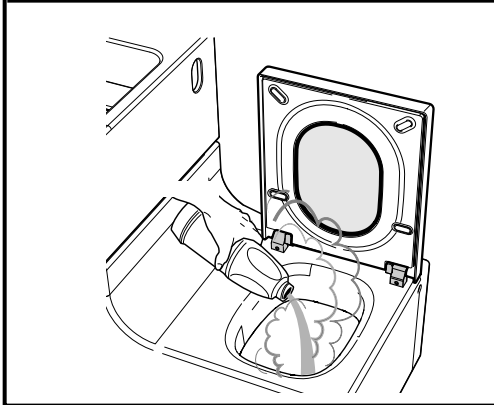
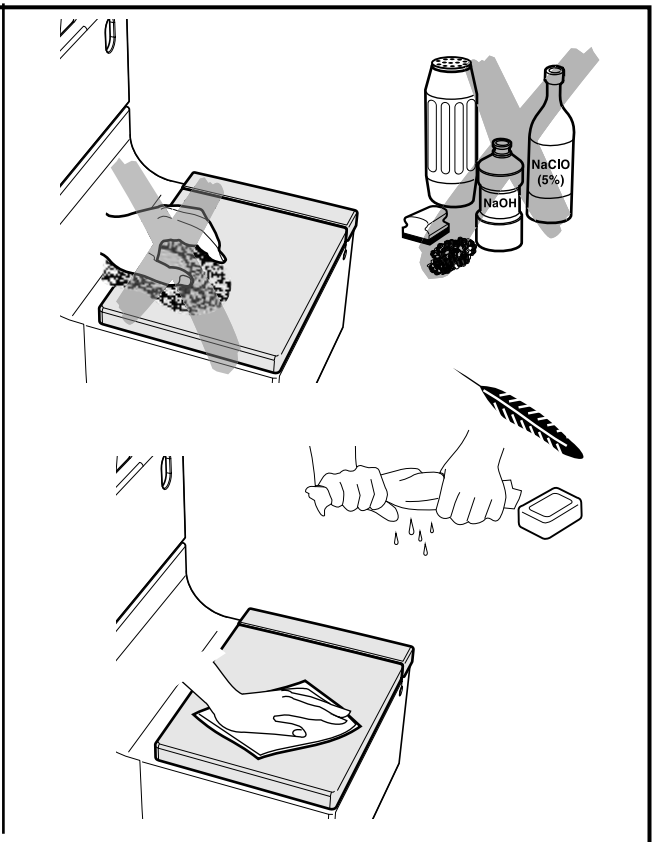
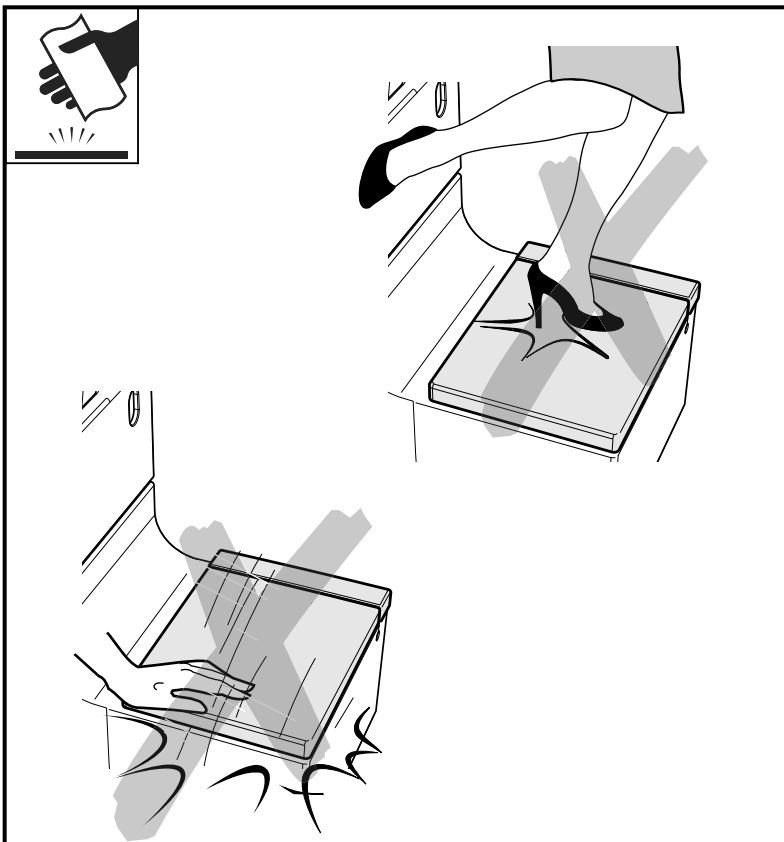
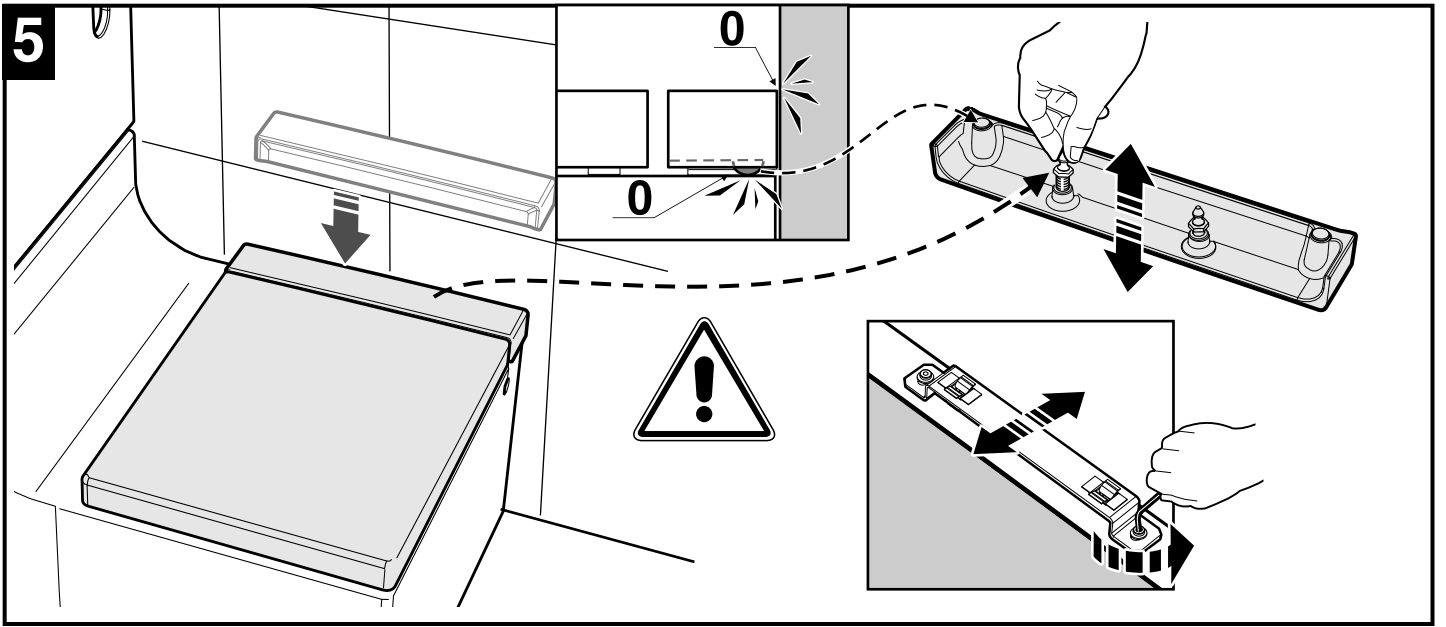

Roca Sanitario, S.A.
 Avda. Diagonal, 513
 08029 Barcelona SPAIN
 Teléfono 93 366 1200
 Fax 93 419 4501
 www.roca.es

Roca

8-02814490a